







Touch-sensitive HD IP Conference Phone

It is time to optimize your conference room with Yealink modern conference phone - the Yealink Touch-sensitive HD IP Conference Phone CP920. With user-centric design philosophy, this new release from Yealink combines simplicity of use with sophistication of features, being perfect for small to medium conference room. In regard of its crystal-clear audio quality, your conversation will sound natural and bright anywhere with well-designed CP920. The Yealink CP920 can be not only paired with your mobile staff - smartphone or PC/tablet via Bluetooth, but also is a good choice for the companies that use a public switched telephone network (PSTN) after combining with CPN10 PSTN Box. As a valuable complement for your conference room, CP920 conference phone strikes an excellent balance between ease-of-use and powerful features, giving you a simply and clearly engaging business conference experience.

| | | | |
|--|---|--|---|
|  Superior audio quality |  PSTN/SIP |  Built-in Wi-Fi |  Built-in Bluetooth |
|  Local 3-way PSTN conference |  Call recording |  Hybrid UC meeting | |



Key Features and Benefits

Sensitive Touch, Elegant Control

This Y-shape phone released from Yealink, representing the first letter Y of Yealink, owns a sensitive touch keypad which perfectly cancels the keypad noise and facilitates your conference room experience by simply putting all of the key conferencing functions at your fingertips.

Superior Audio Quality

The Yealink CP920 conference phone, marrying the Yealink Noise Proof Technology, unburdens the business conversation by reducing annoying noise and minimizing distractions to set audio experience into a new level. Thanks to its built-in 3-microphone array, CP920 owns a 20-foot (6-meter) and 360-degree voice pickup range as if all participants are sitting across the table from each other!

Simultaneous Analog-plus-IP

To protect business owner's investments by supporting the migration to VoIP, CP920 allows you to connect Yealink PSTN box CPN10 with traditional analog phone lines. Without purchasing any extra PSTN server, just cascading two CPN10 can directly implement local three-way PSTN conference and offers flexible modes for business users: analog, IP or simultaneous analog-plus-IP.

Hybrid UC Meeting

With Yealink CP920, up to five parties can join a conference call from different locations, helping your company cut costs and save time. Pairing Yealink CP920 with your smartphone or PC/tablet via Bluetooth allows you to turn the Yealink CP920 into a loudspeaker or microphone with ease. In addition, you can merge your smartphone or PC/tablet, SIP call and PSTN call into one hybrid UC meeting.

- Optimal HD audio, full duplex technology
- Yealink Noise Proof Technology
- 20-foot (6-meter) and 360-degree voice pickup
- Built-in 3-microphone array
- Sensitive touch keypad
- 3.1" 248x120-pixel graphical LCD with backlight
- Power over Ethernet
- 5-way conference call
- Hybrid UC meeting
- Built-in Wi-Fi (2.4GHz, 802.11.b/g/n)
- Built-in Bluetooth 4.0
- Local USB call recording
- Local 3-way PSTN conference via Yealink CPN10

Audio features

- Optimal HD audio
- Yealink Noise Proof Technology
- Background noise suppression
- 20-foot (6-meter) microphone pickup range
- Apply to small to medium conference room
- Built-in 3-microphone array, 360-degree voice pickup
- 56mm diameter and 5w speaker
- Full-duplex speakerphone with AEC
- Echo cancellation tail length is up to 320ms
- Codecs: G722, G722.1C, G726, G729, G723, iLBC, Opus, PCMA, PCMU
- DTMF: In-band, Out-of-band (RFC 2833) and SIP INFO
- VAD, CNG, PLC, AJB, AGC

Phone features

- 1 VoIP account
- Call hold, mute, DND, call recording, hotline
- 5-way conference call
- Flash
- Redial, call waiting, emergency call
- Call forward, call transfer, call return, dial plan
- Ring tone selection/import/delete
- Set date time manually or automatically
- Volume adjustment
- Pairing via Bluetooth

Directory

- Local phonebook up to 1000 entries
- XML/LDAP remote phonebook
- Intelligent search method
- Phonebook search/import/export
- Call history: dialed/received/missed/forwarded
- Black list

IP-PBX features

- Intercom
- Multicast paging
- Anonymous call
- Anonymous call rejection

- Voice mail
- Distinctive ringtone
- Call pickup

Display

- 3.1" 248x120-pixel graphical LCD with backlight
- 25 total keys:
 - 4 soft keys, off-hook key, on-hook key,
 - 12-key numerical keypad, Bluetooth, mute,
 - volume keys, 2 navigation keys, OK key
- Phone lock
- Multilingual user interface
- Caller ID with name and number

Interface

- 1 x RJ45 10/100M Ethernet port
- Built-in Wi-Fi (2.4GHz, 802.11 b/g/n)
- Built-in Bluetooth 4.0
- Power over Ethernet (IEEE 802.3af), class 3
- 1 x USB 2.0 port
- 1 x Security slot

Network and security

- SIP v1 (RFC2543), v2 (RFC3261)
- SIP server redundancy supported
- IPv4/IPv6
- NAT traversal: STUN mode
- Proxy mode and peer-to-peer SIP link mode
- IP assignment: static/DHCP
- HTTP/HTTPS web server
- Time and date synchronization using SNTP
- UDP/TCP/DNS-SRV (RFC 3263)
- QoS: 802.1p/Q tagging (VLAN), Layer 3 ToS, DSCP
- SRTP for voice encryption
- Transport Layer Security (TLS)
- HTTPS certificate manager
- AES encryption for configuration file
- Digest authentication using MD5/MD5-sess
- OpenVPN, IEEE802.1X

Management

- Configuration: browser/phone/auto-provision
- Auto provision via FTP/TFTP/HTTP/HTTPS for mass deploy
- Auto-provision with PnP
- Zero-sp-touch, TR-069
- Reset to factory, reboot
- Package tracing export, system log

Other physical features

- Color: Space Silver
- External Yealink power adapter: AC 100~240V input and DC 12V/1A output
- Power consumption (PSU): 3w-3.8w
- Power consumption (PoE): 3.9w-7.6w
- Dimension (W*D*H): 307.8mm*298.5mm*66.9mm
- Operating humidity: 10~90%
- Storage temperature: -10~40°C (+14~104°F)

Package features

- Package content:
 - Yealink CP920 IP conference phone
 - Ethernet Cable (7.5m CAT5E UTP cable)
 - Quick Start Guide
 - Yealink Power Adapter
- Qty/CTN: 5 PCS
- N.W/CTN: 8.046 kg
- G.W/CTN: 9.062 kg
- Giftbox size: 336mm*364mm*112mm
- Carton Meas: 587mm*348mm*376mm

Compliance

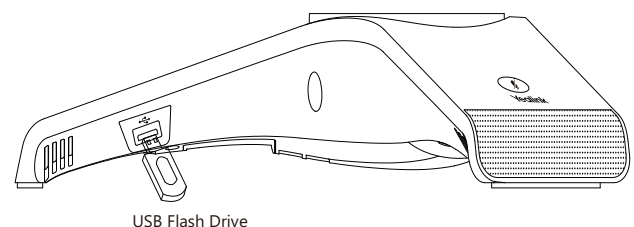
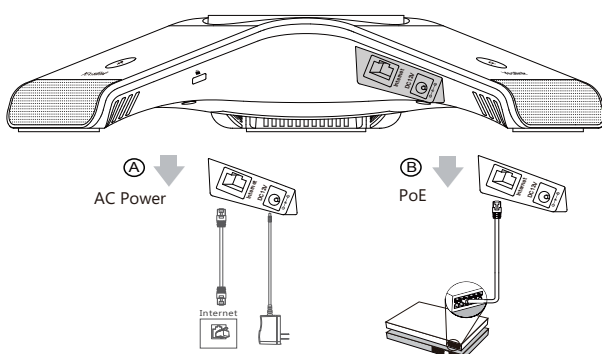



About Yealink

Yealink is a global leading provider of enterprise communication and collaboration solutions, offering video conferencing service to worldwide enterprises. Focusing on research and development, Yealink also insists on innovation and creation. With the outstanding technical patents of cloud computing, audio, video and image processing technology, Yealink has built up a panoramic collaboration solution of audio and video conferencing by merging its cloud services with a series of endpoints products. As one of the best providers in more than 140 countries and regions including the US, the UK and Australia, Yealink ranks No.1 in the global market share of SIP phone shipments.

Copyright

Copyright © 2018 YEALINK(XIAMEN) NETWORK TECHNOLOGY CO., LTD.

Copyright © 2018 Yealink(Xiamen) Network Technology CO., LTD. All rights reserved. No parts of this publication may be reproduced or transmitted in any form or by any means, electronic or mechanical, photocopying, recording, or otherwise, for any purpose, without the express written permission of Yealink(Xiamen) Network Technology CO., LTD.

Technical Support

Visit Yealink WIKI (<http://support.yealink.com/>) for firmware downloads, product documents, FAQ, and more. For better service, we sincerely recommend you to use Yealink Ticketing system (<https://ticket.yealink.com>) to submit all your technical issues.

Distributed by:



E-mail: sales@pulsesupply.com
<https://www.pulsesupply.com/yealink>